



Range of wall mounted in-line duct centrifugal fans, manufactured from high grade corrosion resistant pressed galvanised steel. All model include an enclosed type, single-phase external rotor motor with factory matched backward curved non-stalling impeller.

Motors

All motors are IP44, class B, with ball bearings and safety thermal overload protection.

Electrical supply:

Single phase 230V-50/60Hz.

All models are speed controllable.

On request

VENT-V-160 fitted with 48V-DC motor.

TECHNICAL CHARACTERISTICS

Before installation check that the product electrical characteristics listed on the data plate label (voltage, power, frequency, etc.) match those of the intended electrical supply.

Model	Voltage V/Hz	Speed (rpm)	Maximum absorbed power (W)	Maximum absorbed current (A)	Maximum airflow (m ³ /h)	Sound pressure level* (dB(A))	Ambient temperature (°C)	Weight (kg)	Wiring diagram** (n°)
VENT-V-100L	230V 50/60Hz	2450	74	0,31	350	46	-40°C/+60°C	3,0	19
VENT-V-125L	230V 50/60Hz	2470	80	0,34	450	46	-40°C/+60°C	3,0	19
VENT-V-160L	230V 50/60Hz	2740	124	0,58	800	51	-40°C/+60°C	5,0	19
VENT-V-200L	230V 50/60Hz	2570	152	0,65	1020	52	-40°C/+60°C	5,0	19
VENT-V-250L	230V 50/60Hz	2710	168	0,72	1050	57	-40°C/+60°C	6,0	19
VENT-V-315B	230V 50/60Hz	2520	217	0,95	1430	57	-40°C/+60°C	8,0	19
VENT-V-315L	230V 50/60Hz	2720	280	1,20	1540	59	-40°C/+60°C	8,0	19

* Sound pressure level measured at the fan inlet in dB(A), at 3 m, in free field.

** See section of Wiring Diagrams.

DIMENSIONS (mm)

Mounting with the motor in horizontal position.

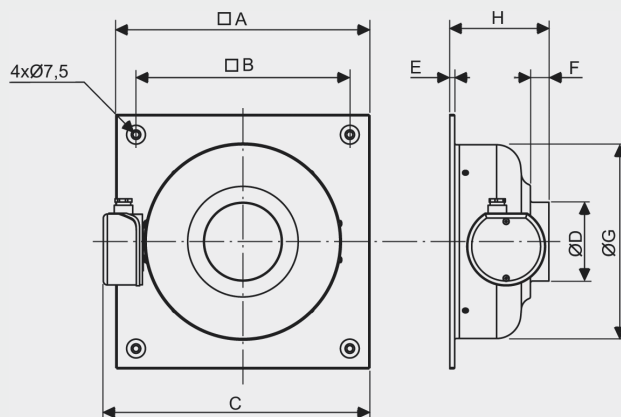

Model	A	B	C	D	E	F	G	H
VENT-V-100L	315	265	331	97,5	6	23	240	123
VENT-V-125L	315	265	331	122,5	6	27	240	127
VENT-V-160L	400	350	418	157	6	28	330	130
VENT-V-200L	400	350	418	198	6	27	330	143
VENT-V-250L	400	350	418	248	6	27	330	132
VENT-V-315L/B	450	400	477	312	6	25	398	147

ACOUSTIC CHARACTERISTICS

Sound power level spectrums (LwA) at three working points of the performance curve (lp: maximum volume).

Model VENT-V		63	125	250	500	1.000	2.000	4.000	8.000	Global	
100L	Inlet	LP	33	42	51	60	63	61	52	41	67
		MP	29	40	50	58	60	58	48	37	64
		HP	30	40	50	57	59	56	46	35	63
	Outlet	LP	35	44	53	69	71	70	62	50	75
		MP	32	42	53	68	69	67	59	46	73
		HP	34	41	53	65	67	65	56	44	71
	Radiated	LP	31	33	41	51	43	45	40	33	53
		MP	27	31	40	49	40	42	36	29	51
		HP	28	31	40	48	39	40	34	27	50

Model VENT-V		63	125	250	500	1.000	2.000	4.000	8.000	Global	
125L	Inlet	LP	31	44	52	61	62	61	56	44	67
		MP	29	41	52	60	59	58	51	38	64
		HP	33	41	58	60	61	58	50	38	66
	Outlet	LP	29	44	51	67	70	68	61	51	74
		MP	29	41	52	66	68	65	57	46	72
		HP	34	42	56	67	69	66	57	46	73
	Radiated	LP	30	40	37	45	45	44	42	33	51
		MP	28	37	37	44	42	41	37	27	48
		HP	32	37	43	44	44	41	36	27	50

Model VENT-V		63	125	250	500	1.000	2.000	4.000	8.000	Global	
160L	Inlet	LP	35	45	57	66	67	65	61	49	71
		MP	33	44	58	64	64	63	57	44	69
		HP	35	47	60	64	64	61	54	41	69
	Outlet	LP	33	45	56	72	75	71	66	55	78
		MP	33	44	57	70	72	68	62	50	75
		HP	36	47	59	70	71	68	60	47	75
	Radiated	LP	35	35	38	51	48	49	43	32	55
		MP	33	35	39	50	45	46	38	27	53
		HP	35	38	41	49	45	44	35	24	52

Model VENT-V		63	125	250	500	1.000	2.000	4.000	8.000	Global	
200L	Inlet	LP	39	50	62	64	67	66	65	61	72
		MP	36	46	59	62	64	63	62	54	69
		HP	40	60	65	66	66	62	59	51	72
	Outlet	LP	37	49	62	71	75	74	71	64	79
		MP	35	46	59	67	71	70	67	58	75
		HP	37	56	64	70	73	70	66	55	77
	Radiated	LP	39	46	39	44	50	51	47	39	56
		MP	36	42	36	42	47	48	44	32	53
		HP	40	56	42	46	49	47	41	29	58

ACOUSTIC CHARACTERISTICS

Sound power level spectrums (LwA) at three working points of the performance curve (lp: maximum volume).

Model VENT-V		63	125	250	500	1.000	2.000	4.000	8.000	Global	
250L	Inlet	LP	39	54	67	66	72	72	71	64	77
		MP	37	51	64	63	69	69	68	58	74
		HP	38	60	72	65	68	64	62	53	75
	Outlet	LP	39	51	64	74	79	80	75	67	84
		MP	37	48	62	70	75	76	72	62	80
		HP	38	56	69	70	74	71	67	56	78
	Radiated	LP	33	49	38	47	53	53	51	42	58
		MP	31	46	35	44	50	50	48	36	55
		HP	32	55	43	46	49	45	42	31	57

Model VENT-V		63	125	250	500	1.000	2.000	4.000	8.000	Global	
315B	Inlet	LP	42	52	65	69	73	72	68	62	77
		MP	39	55	64	66	69	68	63	57	74
		HP	40	55	66	63	65	65	60	53	71
	Outlet	LP	41	50	65	72	80	78	72	67	83
		MP	38	50	64	69	75	73	67	62	78
		HP	40	52	64	66	72	70	64	57	76
	Radiated	LP	42	49	44	51	59	55	53	43	62
		MP	39	52	43	48	55	51	48	38	59
		HP	40	52	45	45	51	48	45	34	57

Model VENT-V		63	125	250	500	1.000	2.000	4.000	8.000	Global	
315L	Inlet	LP	43	54	67	72	75	75	70	64	80
		MP	41	62	68	70	72	71	66	60	77
		HP	42	57	70	69	71	70	65	59	77
	Outlet	LP	45	51	67	76	82	80	74	68	85
		MP	40	52	68	75	79	76	70	65	82
		HP	43	52	69	74	77	74	68	62	81
	Radiated	LP	43	52	41	52	58	58	53	45	63
		MP	41	60	42	50	55	54	49	41	63
		HP	42	55	44	49	54	53	48	40	60

PERFORMANCE CURVES

- q_v : Airflow in m^3/h and m^3/s .
- p_{sf} : Static pressure in mmWG and Pa.
- Dry air at 20°C and 760 mmHg.
- Performance data in accordance with ISO 5801 and AMCA 210-99 Standards.

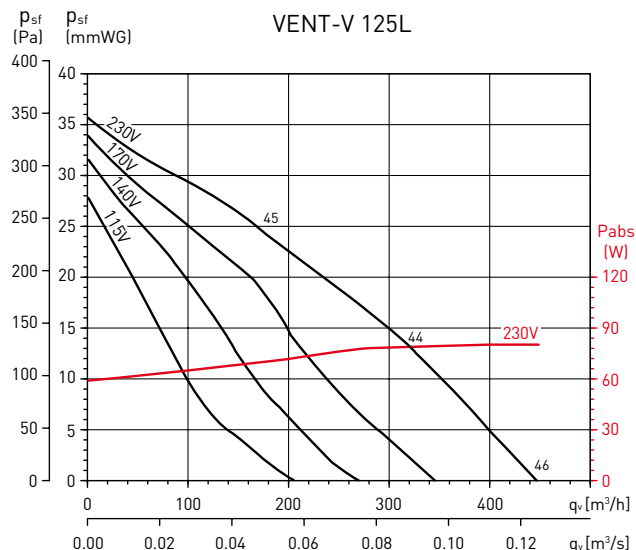
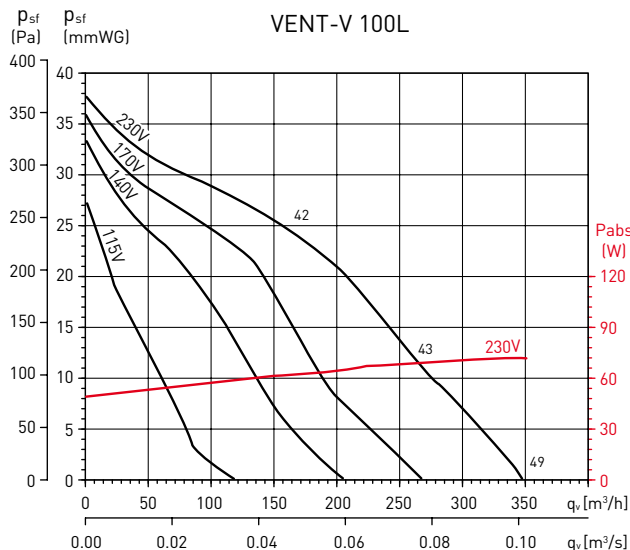

PERFORMANCE CURVES

- q_v : Airflow in m^3/h and m^3/s .
- p_{sf} : Static pressure in mmWG and Pa.
- Dry air at $20^\circ C$ and 760 mmHg.
- Performance data in accordance with ISO 5801 and AMCA 210-99 Standards.

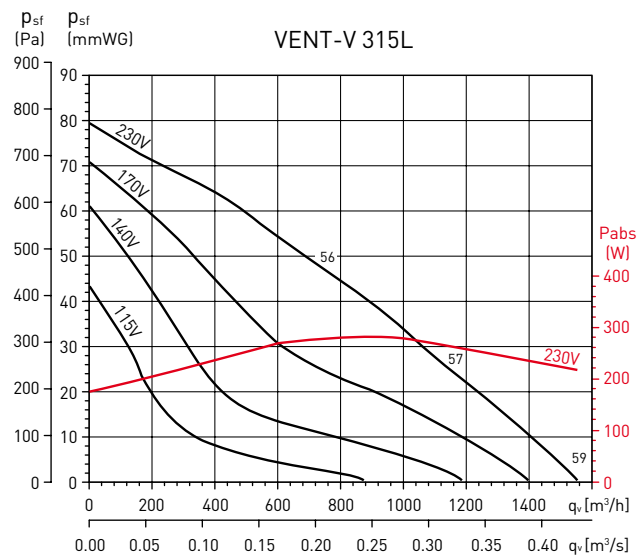
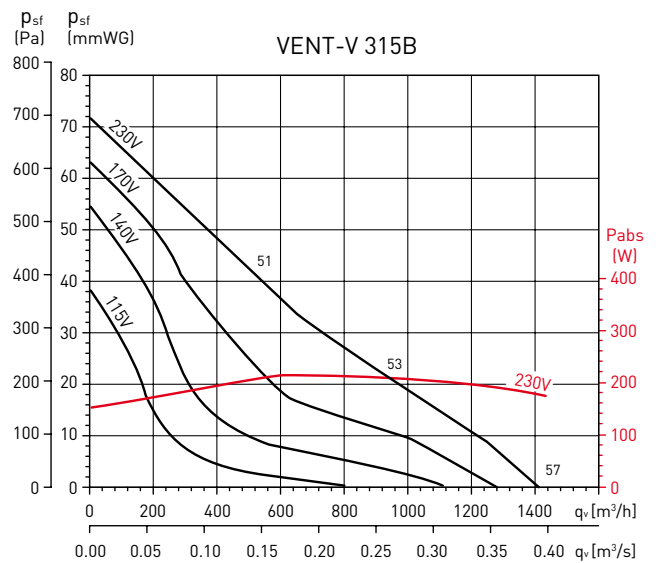
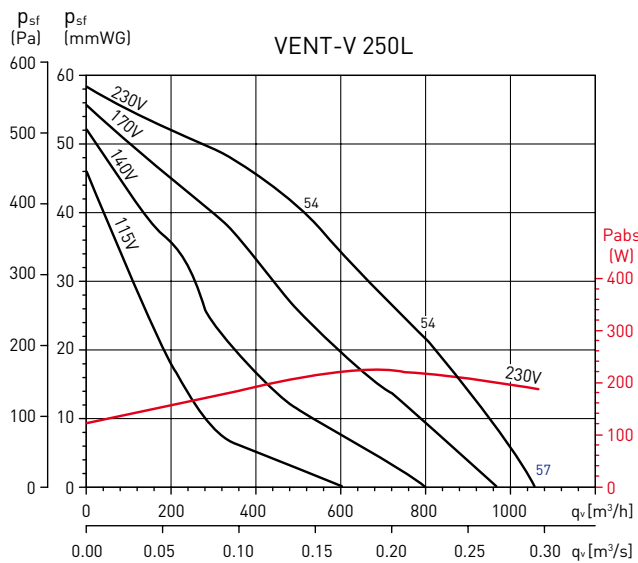
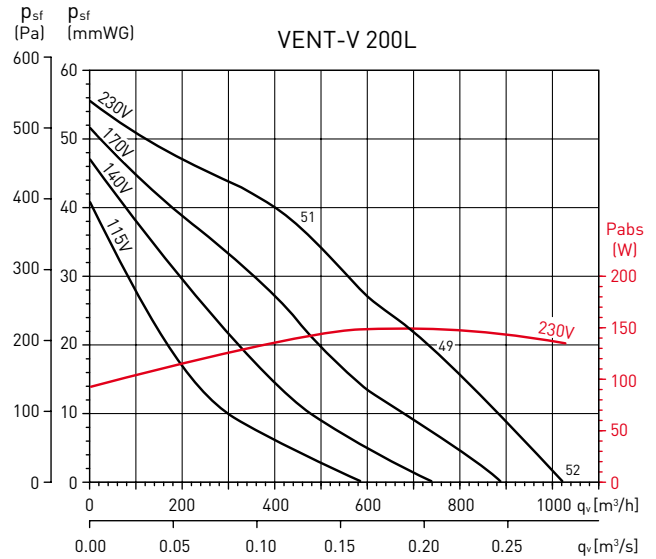
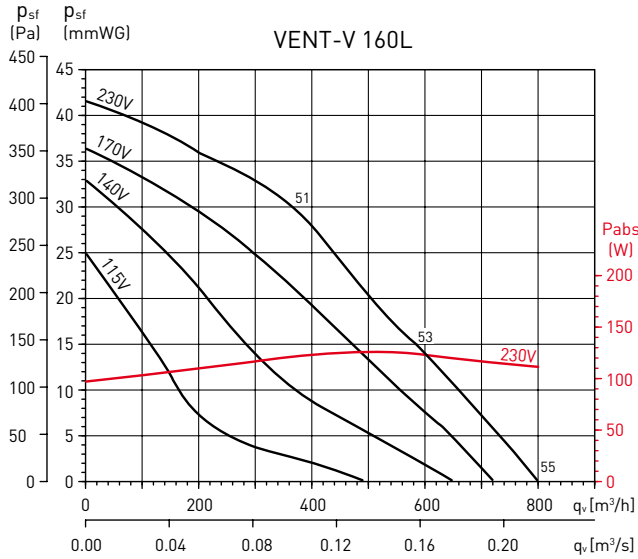

MOUNTING ACCESSORIES



DEF-VENT
Protection grille.



ACOP-VENT
Flexible connectors.



MFL-G4
Filtration box of G4
grade filtration.



SIL
Circular sound
attenuators.

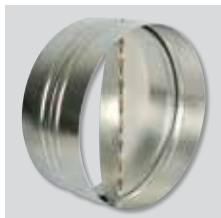

CAR
Backdraught
shutters.

ELECTRICAL ACCESSORIES



REB
Electronic single
phase speed
controllers.



RMB
Autotransformer
single phase speed
controllers.