

# PROTIVKIŠNE REŠETKE WEATHER GRILLES



## BN

- Zidna protivkišna rešetka za ubacivanje ili izvlačenje vazduha sa žičanom mrežom.
- Wall mount weather grille equipped with wire mesh. For intake or exhaust air from/to exterior.

### DIMENZIJE OTVORA / HOLE DIMENSION Visina / Height (mm)

	100	125	150	200	250	300	350	400	450	500
200	15,58	15,58	15,58	15,58						
250	15,58	15,58	15,58	17,14	19,12					
300	15,58	16,29	17,42	19,12	21,24	23,94				
350	16,99	18,13	19,12	20,96	23,22	26,34	27,76			
400	18,55	19,69	20,82	22,80	25,36	28,76	31,58	34,56		
450	20,25	21,39	22,52	24,64	27,19	31,30	35,13	38,66	45,03	
500	21,81	22,95	24,22	26,63	29,32	33,57	39,23	42,77	48,16	51,13
550	23,57	24,64	25,92	28,46	31,44	36,12	42,91	46,88	51,27	56,09
600	25,21	26,34	27,76	30,45	33,42	38,52	46,74	50,98	54,39	61,03
650	26,06	27,19	28,89	31,94	34,41	41,00	49,29	53,96	57,79	65,00
700	26,91	28,04	30,03	33,42	35,40	43,48	51,84	56,94	61,19	68,97
750	28,33	28,89	31,30	34,97	37,53	45,75	54,52	59,91	64,58	72,80
800	28,61	29,88	32,43	36,54	39,37	48,30	58,47	62,74	64,44	76,76
850	29,53	30,66	33,49	38,10	41,36	50,77	60,32	65,71	69,54	80,73
900	30,45	31,44	34,56	39,66	43,34	53,25	62,18	68,69	74,64	84,70
950	31,37	32,30	35,83	41,14	45,39	55,65	64,65	71,67	78,04	88,87
1000	32,30	33,15	37,10	42,63	47,45	58,06	67,13	74,64	81,44	93,05
1050	33,15	34,13	37,96	44,33	49,28	60,48	69,97	77,61	84,83	96,59
1100	33,99	34,97	39,37	45,75	51,27	63,03	72,51	80,58	88,24	100,55
1150	34,97	35,98	40,64	47,16	53,25	65,28	75,07	83,42	91,49	104,52
1200	35,69	36,82	41,79	48,72	55,23	67,70	77,61	86,39	94,89	108,49
1250	36,61	37,69	42,94	50,26	57,55	70,15	80,19	89,32	98,29	112,41
1300	37,53	38,57	44,10	51,79	59,86	72,61	82,76	92,25	101,69	116,33
1350	38,45	39,44	45,26	53,32	62,17	75,06	85,33	95,17	105,09	120,25
1400	39,37	40,31	46,41	54,86	64,49	77,52	87,90	98,10	108,49	124,17
1450	40,29	41,19	47,57	56,39	66,80	79,97	90,47	101,02	111,89	128,09
1500	41,21	42,06	48,72	57,92	69,12	82,43	93,05	103,95	115,28	132,00

CENOVNIK ZA REŠETKE OD  
ELOKSIRANOG ALUMINIJUMA  
U PRIRODNOJ BOJI

PRICELIST FOR GRILLES MADE  
OF ANODIZED ALUMINIUM  
IN NATURAL COLOUR

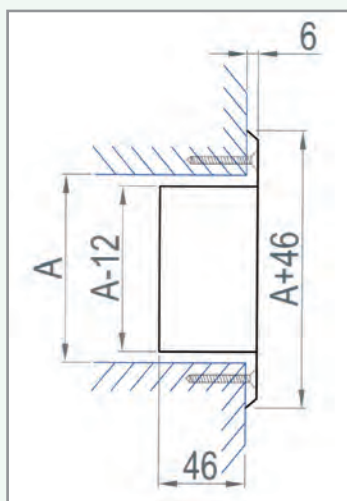

Širina / Width (mm)

### Visina / Height (mm)

	100	125	150	200	250	300	350	400	450	500
200	21,33	21,33	21,33	21,33						
250	21,33	21,33	21,33	22,89	24,87					
300	21,33	22,03	23,17	24,87	26,99	29,69				
350	22,74	23,88	24,87	26,71	28,97	32,09	33,51			
400	24,30	25,44	26,57	28,55	31,11	34,51	37,33	40,31		
450	26,00	27,14	28,27	30,39	32,94	37,05	40,88	44,41	50,78	
500	27,56	28,70	29,96	32,38	35,07	39,32	44,98	48,52	53,91	56,88
550	29,32	30,39	31,67	34,21	37,19	41,87	48,66	52,63	57,02	61,84
600	30,96	32,09	33,51	36,20	39,17	44,27	52,49	56,73	60,14	66,85
650	31,81	32,94	34,64	37,69	40,16	46,75	55,04	59,71	63,54	71,19
700	32,66	33,79	35,77	39,17	41,15	49,23	57,59	62,69	67,01	75,54
750	34,08	34,64	37,05	40,72	43,28	51,50	60,27	65,66	70,73	79,73
800	34,36	35,63	38,18	42,29	45,12	54,05	64,22	68,71	70,58	84,07
850	35,28	36,41	39,24	43,85	47,11	56,52	66,07	71,97	76,16	88,42
900	36,20	37,19	40,31	45,41	49,09	59,00	68,10	75,23	81,75	92,77
950	37,12	38,05	41,58	46,89	51,14	61,40	70,81	78,49	85,47	97,34
1000	38,05	38,90	42,85	48,38	53,20	63,81	73,52	81,75	89,19	101,91
1050	38,90	39,88	43,71	50,08	55,03	66,24	76,63	85,00	92,91	105,78
1100	39,74	40,72	45,12	51,50	57,02	69,03	79,42	88,26	96,64	110,13
1150	40,72	41,73	46,39	52,91	59,00	71,50	82,22	91,37	100,21	114,48
1200	41,44	42,57	47,54	54,47	60,98	74,14	85,00	94,62	103,93	118,82
1250	42,36	43,44	48,69	56,01	63,30	76,83	87,82	97,83	107,65	123,11
1300	43,28	44,32	49,85	57,54	65,61	79,52	90,64	101,03	111,37	127,41
1350	44,20	45,19	51,00	59,07	68,10	82,21	93,46	104,23	115,10	131,70
1400	45,12	46,06	52,16	60,60	70,63	84,90	96,27	107,44	118,82	135,99
1450	46,04	46,94	53,32	62,14	73,16	87,59	99,09	110,64	122,54	140,28
1500	46,96	47,81	54,47	63,67	75,70	90,28	101,91	113,85	126,26	144,58

Širina / Width (mm)

CENOVNIK ZA REŠETKE  
OBOJENE RAL BOJOM  
PLASTIFICIRANE

PRICE LIST FOR GRILLES  
PAINTED IN RAL COLOUR  
ELECTROSTATICALLY

#### NAPOMENA:

\* U slučaju kada imamo rešetku npr. 200x800 uzimamo cenu za rešetku 800x200.

\* Za neke specijalne RAL boje postoji dodatak u ceni. Pozovite nas za detaljnije informacije.

\* Postoji mogućnost skrivene ugradnje sa klipsama (štipaljka) (strana P2, crtež 1A) bez doplate i „П” ramom (strana P2, crtež 1B) uz doplatu.

#### NOTES:

\* In the case where we have a grille i.e. 200x800 we can use the price of 800x200.

\* For some special RAL colours there is extra charge. Call us for more information.

\* Secret fixing is possible with spring clips (page P2, drawing 1A) without extra charge or with "П" frame (page P2, drawing 1B) with extra charge.



### BN-D

- Zidna protivkišna rešetka za ubacivanje ili izvlačenje vazduha sa žičanom mrežom i regulatorom protoka sa suprotnosmernim lamelama.
- Wall mount weather grille equipped with wire mesh. For intake or exhaust air from/to exterior. With opposed blade damper for regulation of air flow.

CENOVNIK ZA REŠETKE OD  
ELOKSIRANOG ALUMINIJUMA  
U PRIRODNOJ BOJI

PRICELIST FOR GRILLES MADE  
OF ANODIZED ALUMINIUM  
IN NATURAL COLOUR

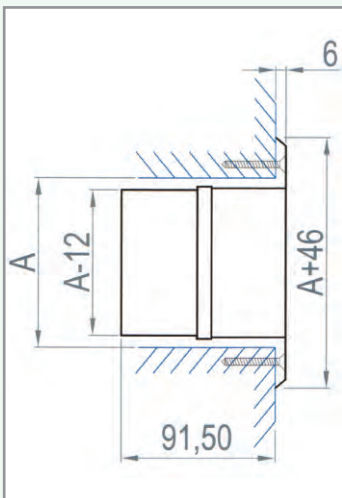

### DIMENZIJE OTVORA / HOLE DIMENSION Visina / Height (mm)

	100	125	150	200	250	300	350	400	450	500
200	23,69	23,69	23,69	23,69						
250	23,69	23,69	23,69	26,06	28,76					
300	23,69	24,36	26,35	28,90	31,72	35,27				
350	24,94	27,05	28,90	31,63	34,55	39,09	41,79			
400	27,35	29,47	31,48	34,27	36,74	42,92	47,06	51,99		
450	29,90	32,01	34,04	37,10	39,55	46,89	51,99	57,84	66,56	
500	32,32	34,43	36,59	39,80	43,21	50,58	57,78	63,64	71,34	75,91
550	34,93	36,97	39,05	42,53	46,32	54,53	62,61	69,40	76,20	82,72
600	37,42	39,53	41,83	45,47	49,09	58,31	67,84	75,25	81,16	90,35
650	38,68	40,72	43,11	47,44	51,28	60,93	71,24	78,91	85,75	96,17
700	39,94	41,92	44,39	49,41	53,47	63,54	74,64	82,58	90,33	102,00
750	41,65	43,19	46,35	52,11	57,07	67,28	80,02	88,67	96,88	109,63
800	42,77	44,83	48,37	55,24	61,46	73,36	89,20	95,02	99,14	114,16
850	44,05	46,28	50,12	57,65	64,80	77,40	92,05	100,41	106,93	122,23
900	45,33	47,73	51,87	60,05	68,13	81,44	94,90	105,80	114,73	130,30
950	46,74	49,71	54,26	63,31	71,74	85,61	99,50	110,97	121,31	139,57
1000	48,16	51,69	56,64	66,56	75,34	89,79	104,10	116,14	127,89	148,85
1050	49,87	53,58	60,19	69,40	78,31	93,06	108,64	120,94	133,97	149,98
1100	51,14	54,81	62,93	72,09	80,78	96,88	112,88	125,06	137,72	154,80
1150	52,96	56,80	64,72	73,92	84,27	99,71	116,41	129,88	143,33	162,30
1200	54,12	58,48	66,71	77,19	87,37	105,52	121,08	134,82	149,98	168,96
1250	55,86	60,61	69,54	79,78	91,43	110,03	126,59	141,01	156,81	176,68
1300	57,61	62,73	72,38	82,38	95,49	114,54	132,09	147,20	163,63	184,40
1350	59,35	64,86	75,21	84,97	99,56	119,05	137,59	153,38	170,45	192,12
1400	61,09	66,99	78,04	87,56	103,62	123,57	143,09	159,57	177,27	199,84
1450	62,84	69,12	80,87	90,16	107,68	128,08	148,60	165,75	184,10	207,56
1500	64,58	71,24	83,71	92,75	111,74	132,59	154,10	171,94	190,92	215,28

Širina / Width (mm)

### Visina / Height (mm)

	100	125	150	200	250	300	350	400	450	500
200	29,44	29,44	29,44	29,44						
250	29,44	29,44	29,44	31,81	34,51					
300	29,44	30,11	32,10	34,65	37,47	41,02				
350	30,69	32,80	34,65	37,38	40,30	44,84	47,54			
400	33,10	35,22	37,23	40,02	42,49	48,67	52,81	57,74		
450	35,65	37,76	39,79	42,85	45,30	52,64	57,74	63,59	72,31	
500	38,06	40,17	42,34	45,55	48,96	56,33	63,53	69,39	77,09	81,66
550	40,68	42,72	44,80	48,28	52,07	60,28	68,35	75,15	81,95	88,47
600	43,17	45,28	47,58	51,22	54,84	64,06	73,59	81,00	86,91	96,16
650	44,43	46,47	48,86	53,19	57,03	66,68	76,99	84,66	91,50	102,36
700	45,69	47,67	50,14	55,16	59,22	69,29	80,39	88,33	96,16	108,57
750	47,39	48,94	52,10	57,86	62,82	73,03	85,77	94,42	103,03	116,56
800	48,52	50,58	54,12	60,99	67,21	79,11	94,94	101,00	105,28	121,47
850	49,80	52,03	55,87	63,40	70,55	83,15	97,79	106,67	113,56	129,92
900	51,08	53,48	57,62	65,80	73,88	87,19	100,82	112,34	121,83	138,37
950	52,49	55,46	60,01	69,06	77,49	91,36	105,66	117,79	128,74	148,04
1000	53,91	57,44	62,39	72,31	81,09	95,54	110,49	123,24	135,64	157,71
1050	55,62	59,33	65,94	75,15	84,06	98,82	115,30	128,33	142,05	159,18
1100	56,89	60,56	68,68	77,84	86,53	102,88	119,79	132,73	146,12	164,38
1150	58,71	62,54	70,47	79,67	90,02	105,93	123,56	137,83	152,05	172,26
1200	59,87	64,23	72,46	82,94	93,12	111,97	128,48	143,05	159,02	179,29
1250	61,61	66,36	75,29	85,53	97,18	116,71	134,22	149,52	166,17	187,38
1300	63,36	68,48	78,13	88,13	101,24	121,46	139,97	155,98	173,31	195,48
1350	65,10	70,61	80,96	90,72	105,48	126,20	145,72	162,44	180,46	203,57
1400	66,84	72,74	83,79	93,31	109,76	130,95	151,47	168,91	187,61	211,66
1450	68,59	74,87	86,62	95,91	114,04	135,70	157,21	175,37	194,75	219,75
1500	70,33	76,99	89,46	98,50	118,33	140,44	162,96	181,84	201,90	227,85

Širina / Width (mm)

CENOVNIK ZA REŠETKE  
OBOJENE RAL BOJOM  
PLASTIFICIRANE

PRICE LIST FOR GRILLES  
PAINTED IN RAL COLOUR  
ELECTROSTATICALLY

#### NAPOMENA:

\* U slučaju kada imamo rešetku npr. 200x800 uzimamo cenu za rešetku 800x200.

\* Za neke specijalne RAL boje postoji dodatak u ceni. Pozovite nas za detaljnije informacije.

\* Postoji mogućnost skrivene ugradnje sa klipsama (štipaljka) (strana P2, crtež 1A) bez doplate i „Π“ ramom (strana P2, crtež 1B) uz doplatu.

#### NOTES:

\* In the case where we have a grille i.e. 200x800 we can use the price of 800x200.

\* For some special RAL colours there is extra charge. Call us for more information.

\* Secret fixing is possible with spring clips (page P2, drawing 1A) without extra charge or with "Π" frame (page P2, drawing 1B) with extra charge.

7



**BN-E**

- Zidna protivkišna rešetka/revizioni otvor za ubacivanje ili izvlačenje vazduha sa žičanom mrežom.
- Wall mount weather grille equipped with wire mesh. For intake or exhaust air from/to exterior. Accesible.

**DIMENZIJE OTVORA / HOLE DIMENSION**  
Visina / Height (mm)

**CENOVNIK ZA REŠETKE OD ELOKSIRANOG ALUMINIJUMA U PRIRODNOJ BOJI**

**PRICELIST FOR GRILLES MADE OF ANODIZED ALUMINIUM IN NATURAL COLOUR**

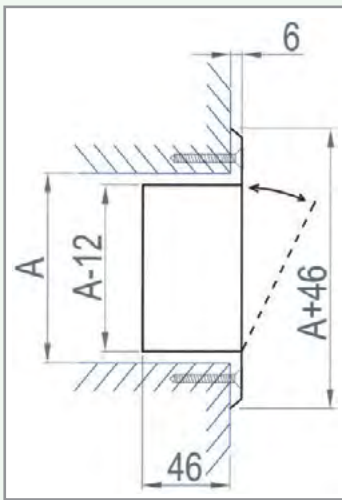

Širina / Width (mm)

	100	125	150	200	250	300	350	400	450	500
200	21,36	21,36	21,36	21,36						
250	21,36	21,36	21,36	23,50	26,23					
300	21,36	22,33	23,89	26,23	29,13	32,83				
350	23,31	24,86	26,23	28,74	31,85	36,13	38,08			
400	25,44	27,00	28,55	31,26	34,78	39,44	43,30	47,39		
450	27,77	29,33	30,89	33,80	37,29	42,93	48,17	53,02	61,76	
500	29,91	31,47	33,21	36,52	40,21	46,05	53,80	58,66	66,04	70,12
550	32,32	33,80	35,55	39,04	43,13	49,53	58,85	64,29	70,32	76,91
600	34,57	36,13	38,08	41,77	45,83	52,83	64,10	69,93	74,60	83,70
650	35,74	37,29	39,63	43,80	47,19	56,23	67,60	74,00	79,25	89,15
700	36,91	38,46	41,18	45,83	48,55	59,63	71,09	78,08	83,91	94,59
750	38,86	39,62	42,93	47,96	51,47	62,75	74,77	82,16	88,57	99,84
800	39,23	40,99	44,47	50,11	54,00	66,24	80,19	86,04	88,38	105,27
850	40,50	42,06	45,93	52,25	56,72	69,63	82,73	90,12	95,37	110,71
900	41,77	43,13	47,39	54,39	59,44	73,02	85,27	94,21	102,37	116,16
950	43,03	44,30	49,14	56,42	62,25	76,32	88,67	98,29	107,03	121,88
1000	44,30	45,46	50,88	58,46	65,07	79,63	92,06	102,37	111,68	127,61
1050	45,46	46,81	52,06	60,80	67,59	82,94	95,96	106,44	116,34	132,46
1100	46,61	47,96	54,00	62,75	70,32	86,44	99,45	110,51	121,01	137,90
1150	47,96	49,34	58,98	64,68	73,02	89,53	102,95	114,41	125,48	143,35
1200	48,95	50,49	57,31	66,82	75,74	92,84	106,44	118,48	130,14	148,79
1250	50,21	51,69	58,89	68,92	78,92	96,21	109,97	122,50	134,80	154,16
1300	51,47	52,89	60,48	71,03	82,09	99,58	113,49	126,51	139,46	159,54
1350	52,73	54,09	62,06	73,13	85,27	102,94	117,02	130,52	144,12	164,91
1400	53,99	55,29	63,65	75,23	88,44	106,31	120,55	134,53	148,79	170,29
1450	55,25	56,49	65,24	77,33	91,62	109,68	124,08	138,54	153,45	175,66
1500	56,52	57,68	66,82	79,43	94,79	113,04	127,61	142,56	158,11	181,03

Visina / Height (mm)

Širina / Width (mm)

	100	125	150	200	250	300	350	400	450	500
200	27,11	27,11	27,11	27,11						
250	27,11	27,11	27,11	29,25	31,97					
300	27,11	28,08	29,64	31,97	34,88	38,58				
350	29,05	30,61	31,97	34,49	37,60	41,88	43,83			
400	31,19	32,75	34,30	37,01	40,53	45,19	49,05	53,14		
450	33,52	35,08	36,64	39,55	43,04	48,68	53,92	58,77	67,51	
500	35,66	37,22	38,96	42,27	45,96	51,80	59,55	64,41	71,79	75,87
550	38,07	39,55	41,30	44,79	48,88	55,28	64,60	70,04	76,07	82,66
600	40,32	41,88	43,83	47,52	51,58	58,58	69,85	75,68	80,35	89,52
650	41,49	43,04	45,38	49,55	52,94	61,98	73,35	79,75	85,00	95,34
700	42,66	44,21	46,93	51,58	54,30	65,38	76,84	83,83	89,74	101,16
750	44,61	45,37	48,68	53,71	57,22	68,50	80,52	87,91	94,72	106,77
800	44,98	46,74	50,22	55,86	59,75	71,99	85,94	92,02	94,51	112,58
850	46,25	47,81	51,68	58,00	62,47	75,38	88,48	96,38	102,00	118,40
900	47,52	48,88	53,14	60,14	65,19	78,77	91,19	100,75	109,48	124,23
950	48,78	50,05	54,89	62,17	68,00	82,07	94,83	105,11	114,46	130,35
1000	50,05	51,21	56,63	64,21	70,82	85,38	98,46	109,48	119,44	136,47
1050	51,21	52,55	57,81	66,55	73,34	88,70	102,62	113,83	124,42	141,65
1100	52,36	53,71	59,75	68,50	76,07	92,44	106,36	118,19	129,42	147,47
1150	53,71	55,09	64,73	70,43	78,77	95,75	110,10	122,35	134,19	153,30
1200	54,70	56,24	63,06	72,57	81,49	99,29	113,83	126,71	139,18	159,12
1250	55,96	57,44	64,64	74,67	84,67	102,89	117,60	131,00	144,16	164,87
1300	57,22	58,64	66,23	76,78	87,84	106,49	121,38	135,29	149,15	170,61
1350	58,48	59,84	67,81	78,88	91,19	110,09	125,15	139,58	154,13	176,36
1400	59,74	61,04	69,40	80,98	94,58	113,69	128,92	143,87	159,12	182,11
1450	61,00	62,24	70,99	83,08	97,98	117,29	132,70	148,17	164,10	187,86
1500	62,27	63,43	72,57	85,18	101,37	120,89	136,47	152,46	169,09	193,61

**CENOVNIK ZA REŠETKE OBOJENE RAL BOJOM PLASTIFICIRANE**

**PRICE LIST FOR GRILLES PAINTED IN RAL COLOUR ELECTROSTATICALLY**

**NAPOMENA:**

- \* U slučaju kada imamo rešetku npr. 200x800 uzimamo cenu za rešetku 800x200.
- \* Za neke specijalne RAL boje postoji dodatak u ceni. Pozovite nas za detaljnije informacije.
- \* Postoji mogućnost skrivene ugradnje zavrtanjima koji bi se zavili kroz vrat rešetke (strana P2, crtež 2).

**NOTES:**

- \* In the case where we have a grille i.e. 200x800 we can use the price of 800x200.
- \* For some special RAL colours there is extra charge. Call us for more information.
- \* Secret fixing is possible with screws in the neck of the grille (page P2, drawing 2).

# PROTIVKIŠNE REŠETKE WEATHER GRILLES



## BN-FA

- Zidna protivkišna rešetka za ubacivanje ili izvlačenje vazduha sa žičanom mrežom i filterom.
- Wall mount weather grille equipped with wire mesh. For intake or exhaust air from/to exterior. With air filter.

## DIMENZIJE OTVORA / HOLE DIMENSION Visina / Height (mm)

	100	125	150	200	250	300	350	400	450	500
200	23,77	23,77	23,77	23,77						
250	23,77	23,77	23,77	25,33	28,21					
300	23,77	24,48	25,61	27,77	32,06	36,92				
350	25,18	26,32	27,31	31,05	35,91	39,60	43,28			
400	26,74	27,89	29,47	34,33	38,79	43,90	49,24	54,74		
450	28,45	29,58	32,33	37,62	41,44	48,34	55,06	61,37	68,39	
500	30,00	32,03	35,03	40,06	45,08	52,50	61,31	66,21	72,49	78,16
550	31,76	34,59	37,89	42,34	48,85	56,94	67,26	71,46	78,09	85,83
600	33,86	37,16	40,74	45,59	52,34	61,23	71,28	76,94	83,59	93,48
650	35,43	38,87	43,03	48,34	54,97	65,61	73,95	82,08	89,48	100,15
700	37,01	40,73	44,22	51,08	57,48	68,34	78,33	87,22	95,25	106,83
750	39,15	42,44	45,56	53,90	61,25	70,98	82,97	92,35	101,14	113,35
800	40,14	43,64	47,57	56,74	63,38	74,25	88,75	97,35	103,38	118,21
850	41,78	44,69	49,64	59,55	65,57	78,35	92,55	102,48	110,96	124,78
900	43,43	45,70	51,59	62,37	67,67	82,44	96,25	107,62	116,62	131,34
950	45,07	47,31	53,87	65,12	71,14	86,48	100,67	112,76	122,39	138,11
1000	46,06	48,92	56,03	66,85	74,48	90,51	104,98	116,10	128,08	144,87
1050	46,97	50,66	57,90	68,79	77,73	94,54	109,77	121,14	133,86	151,00
1100	47,87	52,38	60,19	70,38	81,01	98,72	114,15	126,19	139,54	157,56
1150	49,48	54,15	62,47	72,04	84,39	102,59	116,85	131,09	145,18	164,12
1200	50,84	55,74	64,49	74,68	87,68	106,63	121,14	136,14	150,85	168,26
1250	52,38	57,37	66,66	77,29	91,40	110,71	125,58	141,14	156,65	174,37
1300	53,93	59,13	68,02	79,90	95,01	114,78	129,91	146,13	162,32	180,77
1350	55,48	60,77	69,84	82,52	98,73	117,71	134,35	151,13	166,13	187,16
1400	57,04	62,40	71,43	85,14	102,34	121,05	138,69	156,14	170,94	193,56
1450	58,59	64,02	73,01	87,75	106,06	125,05	143,12	161,14	176,62	199,96
1500	60,14	65,78	74,57	90,37	109,67	129,07	147,46	164,58	182,20	206,35

CENOVNIK ZA REŠETKE OD  
ELOKSIRANOG ALUMINIJUMA  
U PRIRODNOJ BOJI

PRICELIST FOR GRILLES MADE  
OF ANODIZED ALUMINIUM  
IN NATURAL COLOUR

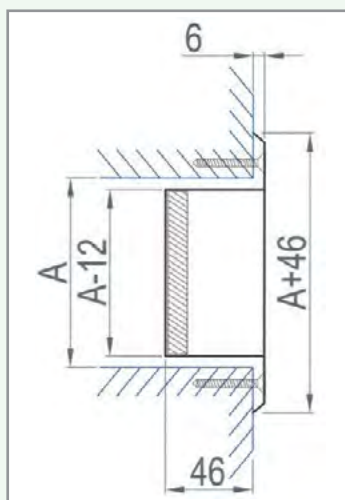

Širina / Width (mm)

Visina / Height (mm)

	100	125	150	200	250	300	350	400	450	500
200	29,52	29,52	29,52	29,52						
250	29,52	29,52	29,52	31,08	33,96					
300	29,52	30,23	31,36	33,52	37,81	42,67				
350	30,94	32,07	33,07	36,80	41,66	45,34	49,03			
400	32,49	33,63	35,22	40,08	44,54	49,65	54,99	60,50		
450	34,20	35,33	38,08	43,36	47,19	54,09	60,81	67,12	74,13	
500	35,75	37,79	40,78	45,81	50,84	58,25	67,06	71,95	78,24	83,91
550	37,51	40,33	43,63	48,09	54,61	62,68	73,01	77,21	83,85	91,57
600	39,61	42,91	46,49	51,34	58,10	66,98	77,02	82,69	89,34	99,29
650	41,19	44,63	48,78	54,09	60,73	71,35	79,70	87,83	95,22	106,34
700	42,76	46,48	49,97	56,83	63,23	74,10	84,08	92,96	101,07	113,40
750	44,90	48,19	51,31	59,65	67,00	76,73	88,72	98,10	107,29	120,29
800	45,89	49,39	53,32	62,48	69,13	80,00	94,50	103,32	109,51	125,53
850	47,53	50,44	55,39	65,30	71,32	84,10	98,30	108,74	117,58	132,47
900	49,18	51,45	57,34	68,11	73,42	88,20	102,16	114,17	123,73	139,41
950	50,82	53,06	59,62	70,87	76,88	92,23	106,83	119,58	129,82	146,57
1000	51,81	54,67	61,78	72,60	80,23	96,26	111,37	123,20	135,84	153,73
1050	52,72	56,41	63,65	74,55	83,48	100,30	116,43	128,54	141,94	160,20
1100	53,62	58,14	65,94	76,13	86,76	104,72	121,06	133,86	147,95	167,13
1150	55,24	59,90	68,22	77,78	90,15	108,81	123,99	139,04	153,89	174,07
1200	56,58	61,50	70,25	80,43	93,43	113,08	128,54	144,37	159,89	178,59
1250	58,14	63,13	72,41	83,04	97,15	117,39	133,21	149,65	166,01	185,08
1300	59,68	64,88	73,77	85,66	100,76	121,70	137,79	154,93	172,01	191,84
1350	61,23	66,52	75,59	88,27	104,65	124,86	142,48	160,20	176,13	198,62
1400	62,78	68,14	77,18	90,88	108,48	128,43	147,06	165,48	181,27	205,39
1450	64,34	69,77	78,76	93,50	112,42	132,67	151,74	170,75	187,27	212,16
1500	65,89	71,53	80,32	96,12	116,26	136,92	156,33	174,47	193,18	218,93

CENOVNIK ZA REŠETKE  
OBOJENE RAL BOJOM  
PLASTIFICIRANE

PRICE LIST FOR GRILLES  
PAINTED IN RAL COLOUR  
ELECTROSTATICALLY

### NAPOMENA:

\* U slučaju kada imamo rešetku npr. 200x800 uzimamo cenu za rešetku 800x200.

\* Za neke specijalne RAL boje postoji dodatak u ceni. Pozovite nas za detaljnije informacije.

\* Postoji mogućnost skrivene ugradnje sa klipsama (štipaljka) (strana P2, crtež 1A) bez doplate i „Π” ramom (strana P2, crtež 1B) uz doplatu.

### NOTES:

\* In the case where we have a grille i.e. 200x800 we can use the price of 800x200.

\* For some special RAL colours there is extra charge. Call us for more information.

\* Secret fixing is possible with spring clips (page P2, drawing 1A) without extra charge or with "Π" frame (page P2, drawing 1B) with extra charge.



### BN-D-E

- Zidna protivkišna rešetka/revizioni otvor za ubacivanje ili izvlačenje vazduha sa žičanom mrežom i regulatorom protoka sa suprotnosmernim lamelama.
- Wall mount weather grille equipped with wire mesh. For intake or exhaust air from/to exterior. Accesible and with oposed blade damper for regulation of airflow.

CENOVNIK ZA REŠETKE OD  
ELOKSIRANOG ALUMINIJUMA  
U PRIRODNOJ BOJI

PRICELIST FOR GRILLES MADE  
OF ANODIZED ALUMINIUM  
IN NATURAL COLOUR

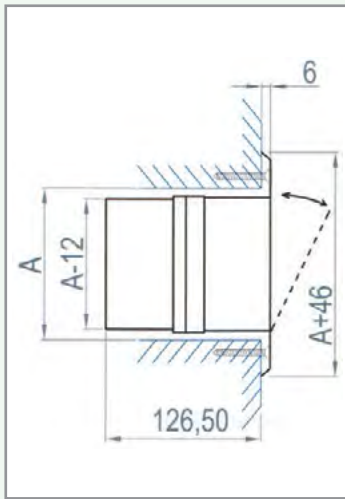

Širina / Width (mm)

### DIMENZIJE OTVORA / HOLE DIMENSION

Visina / Height (mm)

	100	125	150	200	250	300	350	400	450	500
200	29,48	29,48	29,48	29,48						
250	29,48	29,48	29,48	32,42	35,86					
300	29,48	30,40	32,82	36,00	39,61	44,16				
350	31,25	33,79	36,00	39,42	43,18	48,88	52,10			
400	34,24	36,78	39,21	42,74	46,16	53,61	58,78	64,82		
450	37,42	39,96	42,40	46,26	49,66	58,52	65,03	72,19	83,29	
500	40,42	42,95	45,59	49,69	54,10	63,05	72,35	79,52	89,23	94,90
550	43,68	46,13	48,68	53,11	58,00	67,94	78,54	86,81	95,25	103,55
600	46,78	49,31	52,15	56,78	61,50	72,62	85,20	94,19	101,37	113,02
650	48,36	50,83	53,85	59,30	64,06	76,15	89,55	98,96	107,21	120,32
700	49,94	52,34	55,55	61,82	66,62	79,69	93,90	103,72	113,05	127,62
750	52,17	53,92	57,98	65,10	71,01	84,27	100,26	110,91	120,87	136,67
800	53,40	55,94	60,41	68,81	76,08	91,31	110,91	118,33	123,08	142,66
850	55,02	57,68	62,56	71,80	80,16	96,26	114,45	124,82	132,76	152,21
900	56,64	59,41	64,71	74,78	84,23	101,21	117,99	131,32	142,45	161,76
950	58,40	61,71	67,56	78,59	88,60	106,28	123,51	137,59	150,29	172,59
1000	60,16	64,01	70,42	82,39	92,97	111,36	129,03	143,86	158,13	183,41
1050	62,18	66,25	74,29	85,87	96,62	115,52	134,63	149,77	165,48	185,85
1100	63,76	67,80	77,55	89,08	99,83	120,29	139,82	154,99	170,49	192,15
1150	65,95	70,15	83,06	91,44	104,05	123,96	144,30	160,87	177,32	201,13
1200	67,37	72,15	82,23	95,29	107,88	130,66	149,91	166,91	185,23	209,25
1250	69,46	74,61	85,49	98,45	112,80	136,09	156,37	174,19	193,32	218,43
1300	71,54	77,06	88,76	101,61	117,73	141,51	162,83	181,46	201,40	227,60
1350	73,63	79,51	92,02	104,78	122,65	146,94	169,29	188,73	209,49	236,78
1400	75,72	81,96	95,28	107,94	127,57	152,36	175,75	196,00	217,57	245,95
1450	77,80	84,42	98,54	111,10	132,50	157,78	182,20	203,27	225,66	255,13
1500	79,89	86,87	101,81	114,26	137,42	163,21	188,66	210,55	233,74	264,31

Visina / Height (mm)

Širina / Width (mm)

	100	125	150	200	250	300	350	400	450	500
200	35,23	35,23	35,23	35,23						
250	35,23	35,23	35,23	38,17	41,61					
300	35,23	36,15	38,57	41,75	45,36	49,91				
350	37,00	39,54	41,75	45,17	48,93	54,63	57,85			
400	39,99	42,53	44,96	48,49	51,91	59,36	64,53	70,57		
450	43,17	45,71	48,15	52,01	55,41	64,27	70,78	77,94	89,04	
500	46,17	48,70	51,34	55,44	59,85	68,80	78,10	85,27	94,98	100,65
550	49,43	51,87	54,43	58,86	63,75	73,69	84,29	92,56	101,00	109,30
600	52,53	55,06	57,90	62,53	67,25	78,36	90,95	99,94	107,12	118,83
650	54,11	56,58	59,60	65,05	69,81	81,90	95,30	104,71	112,96	126,51
700	55,69	58,09	61,30	67,57	72,37	85,44	99,65	109,47	118,88	134,19
750	57,92	59,67	63,73	70,85	76,76	90,02	106,01	116,66	127,02	143,60
800	59,15	61,69	66,16	74,56	81,83	97,06	116,66	124,30	129,21	149,98
850	60,77	63,43	68,31	77,55	85,91	102,01	120,20	131,08	139,39	159,90
900	62,39	65,16	70,46	80,53	89,98	106,96	123,92	137,86	149,56	169,83
950	64,15	67,46	73,31	84,34	94,35	112,03	129,67	144,42	157,73	181,05
1000	65,91	69,76	76,17	88,14	98,72	117,11	135,43	150,97	165,89	192,27
1050	67,93	72,00	80,04	91,62	102,37	121,28	141,29	157,16	173,56	195,05
1100	69,51	73,55	83,30	94,83	105,58	126,29	146,72	162,66	178,90	201,72
1150	71,70	75,90	88,81	97,19	109,80	130,18	151,45	168,81	186,03	211,08
1200	73,12	77,90	87,98	101,04	113,63	137,11	157,30	175,14	194,27	219,58
1250	75,21	80,36	91,24	104,20	118,55	142,77	164,00	182,69	202,68	229,13
1300	77,29	82,81	94,51	107,36	123,48	148,43	170,71	190,24	211,09	238,68
1350	79,38	85,26	97,77	110,53	128,57	154,08	177,41	197,79	219,50	248,23
1400	81,47	87,71	101,03	113,69	133,71	159,74	184,12	205,34	227,91	257,78
1450	83,55	90,16	104,29	116,85	138,86	165,40	190,82	212,90	236,31	267,33
1500	85,64	92,62	107,56	120,01	144,00	171,06	197,53	220,45	244,72	276,88

CENOVNIK ZA REŠETKE  
OBOJENE RAL BOJOM  
PLASTIFICIRANE

PRICE LIST FOR GRILLES  
PAINTED IN RAL COLOUR  
ELECTROSTATICALLY

#### NAPOMENA:

- \* U slučaju kada imamo rešetku npr. 200x800 uzimamo cenu za rešetku 800x200.
- \* Za neke specijalne RAL boje postoji dodatak u ceni. Pozovite nas za detaljnije informacije.
- \* Postoji mogućnost skrivene ugradnje zavrtinjama koji bi se zavili kroz vrat rešetke (strana P2, crtež 2).

#### NOTES:

- \* In the case where we have a grille i.e. 200x800 we can use the price of 800x200.
- \* For some special RAL colours there is extra charge. Call us for more information.
- \* Secret fixing is possible with screws in the neck of the grille (page P2, drawing 2).

7

# PROTIVKIŠNE REŠETKE WEATHER GRILLES



## BN-D-FA

- Zidna protivkišna rešetka za ubacivanje ili izvlačenje vazduha sa žičanom mrežom i regulatorom protoka sa suprotnosmernim lamelama i filterom
- Wall mount weather grille equipped with wire mesh. For intake or exhaust air from/to exterior. With air filter and opposed blade damper for regulation of airflow.

### DIMENZIJE OTVORA / HOLE DIMENSION Visina / Height (mm)

	100	125	150	200	250	300	350	400	450	500
200	31,89	31,89	31,89	31,89						
250	31,89	31,89	31,89	34,25	37,84					
300	31,89	32,55	34,55	37,55	42,54	48,25				
350	33,14	35,25	37,09	41,73	47,24	52,34	57,30			
400	35,54	37,66	40,14	45,81	50,18	58,06	64,72	72,18		
450	38,10	40,20	43,85	50,08	53,81	63,92	71,92	80,54	89,91	
500	40,51	43,51	47,40	53,24	58,98	69,50	79,86	87,06	95,68	102,94
550	43,12	46,92	51,02	56,42	63,73	75,35	86,95	93,98	103,02	112,46
600	46,07	50,34	54,81	60,61	68,02	81,02	92,37	101,21	110,36	122,79
650	48,05	52,41	57,24	63,85	71,85	85,52	95,90	107,03	117,44	131,32
700	50,03	54,61	58,58	67,07	75,55	88,41	101,14	112,86	124,40	139,85
750	52,46	56,74	60,60	71,04	80,79	92,51	108,46	121,11	133,44	150,18
800	54,31	58,59	63,51	75,43	85,47	99,32	119,48	129,63	138,07	155,61
850	56,31	60,31	66,27	79,09	89,01	104,97	124,28	137,18	148,36	166,28
900	58,30	61,99	68,91	82,76	92,46	110,64	128,96	144,73	156,70	176,94
950	60,44	64,73	72,30	87,28	97,48	116,44	135,52	152,07	165,67	188,80
1000	61,92	67,47	75,57	90,78	102,38	122,24	141,95	157,59	174,53	200,67
1050	63,69	70,11	80,13	93,86	106,76	127,12	148,45	164,47	182,99	204,40
1100	65,02	72,22	83,75	96,72	110,52	132,57	154,52	170,66	189,02	211,81
1150	67,48	74,96	86,55	98,80	115,42	137,02	158,19	177,56	197,02	221,90
1200	69,25	77,41	89,42	103,14	119,81	144,45	164,61	184,57	205,95	228,73
1250	71,63	80,29	93,26	106,82	125,28	150,58	171,98	192,83	215,17	238,64
1300	74,01	83,30	96,30	110,50	130,64	156,72	179,25	201,08	224,26	248,83
1350	76,38	86,19	99,79	114,17	136,12	161,70	186,62	209,34	231,49	259,03
1400	78,76	89,07	103,07	117,85	141,47	167,09	193,88	217,60	239,73	269,23
1450	81,13	91,95	106,31	121,52	146,95	173,16	201,25	225,86	248,83	279,43
1500	83,51	94,96	109,55	125,19	152,30	179,23	208,51	232,56	257,84	289,62

### CENOVNIK ZA REŠETKE OD ELOKSIRANOG ALUMINIJUMA U PRIRODNOJ BOJI

### PRICELIST FOR GRILLES MADE OF ANODIZED ALUMINIUM IN NATURAL COLOUR

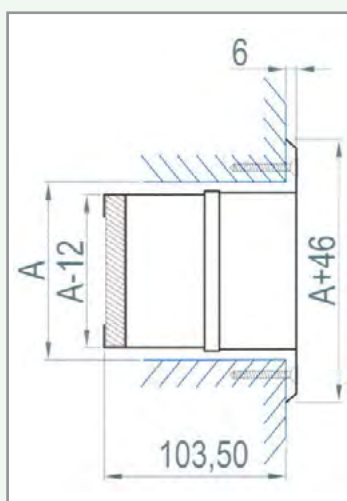

### Visina / Height (mm)

	100	125	150	200	250	300	350	400	450	500
200	37,64	37,64	37,64	37,64						
250	37,64	37,64	37,64	40,01	43,59					
300	37,64	38,30	40,29	43,30	48,28	53,99				
350	38,88	41,00	42,84	47,48	52,99	58,09	63,05			
400	41,29	43,41	45,88	51,56	55,93	63,81	70,47	77,92		
450	43,85	45,95	49,59	55,83	59,56	69,67	77,67	86,29	95,66	
500	46,26	49,26	53,15	58,99	64,73	75,25	85,61	92,82	101,42	108,69
550	48,87	52,66	56,77	62,17	69,48	81,10	92,70	99,73	108,78	118,21
600	51,82	56,09	60,56	66,36	73,77	86,77	98,13	106,95	116,11	128,60
650	53,80	58,15	62,99	69,59	77,59	91,28	101,65	112,78	123,19	137,51
700	55,78	60,36	64,33	72,83	81,31	94,16	106,88	118,61	130,22	146,42
750	58,21	62,49	66,35	76,78	86,54	98,26	114,21	126,86	139,59	157,11
800	60,05	64,35	69,26	81,18	91,22	105,07	125,23	135,61	144,21	162,92
850	62,05	66,06	72,02	84,84	94,76	110,73	130,03	143,44	154,98	173,97
900	64,05	67,74	74,66	88,51	98,22	116,39	134,89	151,28	163,82	185,01
950	66,19	70,48	78,05	93,03	103,23	122,19	141,67	158,89	173,10	197,27
1000	67,67	73,22	81,32	96,53	108,13	127,99	148,34	164,70	182,28	209,53
1050	69,44	75,85	85,88	99,62	112,51	132,88	155,11	171,86	191,08	213,60
1100	70,76	77,97	89,50	102,47	116,27	138,57	161,42	178,33	197,43	221,39
1150	73,22	80,72	92,30	104,55	121,17	143,23	165,33	185,50	205,73	231,86
1200	75,01	83,16	95,18	108,89	125,56	150,89	172,01	192,80	214,99	239,06
1250	77,38	86,03	99,01	112,57	131,04	157,27	179,62	201,34	224,52	249,35
1300	79,76	89,05	102,05	116,24	136,39	163,63	187,13	209,87	233,95	259,91
1350	82,13	91,94	105,54	119,92	142,04	168,85	194,74	218,41	241,50	270,49
1400	84,51	94,82	108,81	123,60	147,61	174,47	202,26	226,95	250,06	281,05
1450	86,88	97,70	112,06	127,27	153,30	180,78	209,86	235,49	259,48	291,63
1500	89,26	100,71	115,31	130,95	158,88	187,08	217,38	242,47	268,81	302,20

### CENOVNIK ZA REŠETKE OBOJENE RAL BOJOM PLASTIFICIRANE

### PRICE LIST FOR GRILLES PAINTED IN RAL COLOUR ELECTROSTATICALLY

#### NAPOMENA:

\* U slučaju kada imamo rešetku npr. 200x800 uzimamo cenu za rešetku 800x200.

\* Za neke specijalne RAL boje postoji dodatak u ceni. Pozovite nas za detaljnije informacije.

\* Postoji mogućnost skrivene ugradnje sa klipsama (štikaljkama) (strana P2, crtež 1A) bez doplate i „Π” ramom (strana P2, crtež 1B) uz doplatu.

#### NOTES:

\* In the case where we have a grille i.e. 200x800 we can use the price of 800x200.

\* For some special RAL colours there is extra charge. Call us for more information.

\* Secret fixing is possible with spring clips (page P2, drawing 1A) without extra charge or with "Π" frame (page P2, drawing 1B) with extra charge.

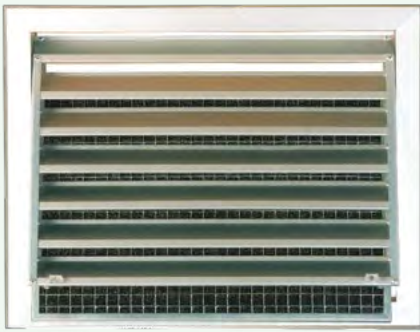

### BN-E-FA

- Zidna protivkišna rešetka/revizioni otvor za ubacivanje ili izvlačenje vazduha sa žičanom mrežom i filterom.
- Wall mount weather grille equipped with wire mesh. For intake or exhaust air from/to exterior. Accesible with air filter.

### DIMENZIJE OTVORA / HOLE DIMENSION

Visina / Height (mm)

CENOVNIK ZA REŠETKE OD  
ELOKSIRANOG ALUMINIJUMA  
U PRIRODNOJ BOJI

PRICELIST FOR GRILLES MADE  
OF ANODIZED ALUMINIUM  
IN NATURAL COLOUR

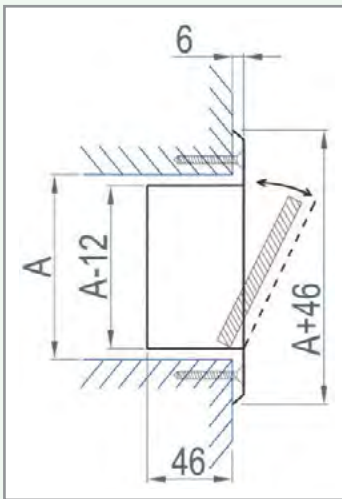

Širina / Width (mm)

	100	125	150	200	250	300	350	400	450	500
200	29,55	29,55	29,55	29,55						
250	29,55	29,55	29,55	31,69	35,31					
300	29,55	30,53	32,08	34,88	39,95	45,81				
350	31,50	33,06	34,42	38,84	44,54	49,38	53,60			
400	33,63	35,20	37,20	42,80	48,21	54,58	60,96	67,57		
450	35,97	37,52	40,69	46,77	51,54	59,96	68,10	75,73	85,11	
500	38,10	40,55	44,03	49,96	55,98	64,98	75,88	82,09	90,37	97,16
550	40,51	43,74	47,52	52,92	60,54	70,35	83,20	88,87	97,14	106,65
600	43,23	46,94	51,06	56,91	64,76	75,54	88,64	95,88	103,79	116,15
650	45,12	48,98	53,76	60,20	67,75	80,83	92,26	102,12	110,95	124,29
700	47,00	51,15	55,38	63,49	70,62	84,49	97,59	108,36	117,98	132,44
750	49,67	53,17	57,19	66,89	75,19	87,98	103,21	114,60	125,13	140,39
800	50,77	54,75	59,61	70,30	78,00	92,19	110,47	120,65	127,31	146,72
850	52,75	56,08	62,08	73,70	80,93	97,21	114,96	126,89	136,80	154,77
900	54,74	57,38	64,42	77,09	83,77	102,22	119,34	133,14	144,35	162,80
950	56,73	59,32	67,17	80,40	88,00	107,15	124,69	139,38	151,38	171,11
1000	58,06	61,23	69,81	82,68	92,10	112,07	129,91	143,82	158,33	179,43
1050	59,28	63,33	71,99	85,26	96,04	117,00	135,75	149,96	165,37	186,87
1100	60,49	65,37	74,82	87,38	100,06	122,13	141,09	156,11	172,32	194,90
1150	62,47	67,51	80,81	89,56	104,17	126,84	144,73	162,08	179,17	202,94
1200	64,08	69,42	80,02	92,78	108,19	131,77	149,96	168,23	186,11	208,56
1250	65,98	71,37	82,61	95,96	112,77	136,76	155,36	174,32	193,16	216,13
1300	67,87	73,46	84,40	99,14	117,24	141,75	160,65	180,40	200,10	223,97
1350	69,76	75,41	86,64	102,33	121,83	145,59	166,05	186,48	205,16	231,83
1400	71,65	77,36	88,67	105,51	126,29	149,84	171,34	192,57	211,24	239,68
1450	73,55	79,32	90,68	108,69	130,87	154,76	176,73	198,66	218,17	247,54
1500	75,44	81,40	92,67	111,87	135,35	159,69	182,03	203,18	225,02	255,39

### Visina / Height (mm)

	100	125	150	200	250	300	350	400	450	500
200	35,30	35,30	35,30	35,30						
250	35,30	35,30	35,30	37,44	41,06					
300	35,30	36,28	37,83	40,63	45,70	51,56				
350	37,24	38,80	40,17	44,59	50,29	55,13	59,35			
400	39,37	40,95	42,95	48,55	53,97	60,33	66,71	73,33		
450	41,72	43,27	46,44	52,52	57,29	65,71	73,85	81,49	90,86	
500	43,86	46,31	49,78	55,70	61,73	70,72	81,63	87,84	96,13	102,91
550	46,26	49,49	53,27	58,67	66,29	76,09	88,95	94,62	102,89	112,41
600	48,98	52,70	56,81	62,66	70,51	81,29	94,38	101,63	109,55	121,96
650	50,86	54,73	59,51	65,95	73,51	86,58	98,00	107,87	116,69	130,49
700	52,75	56,90	61,12	69,25	76,37	90,24	103,34	114,11	123,80	139,02
750	55,42	58,92	62,94	72,64	80,94	93,73	108,96	120,35	131,28	147,32
800	56,52	60,50	65,36	76,05	83,75	97,94	116,22	126,62	133,44	154,03
850	58,50	61,83	67,83	79,45	86,68	102,96	120,70	133,15	143,41	162,46
900	60,50	63,13	70,17	82,85	89,52	107,96	125,26	139,68	151,46	170,87
950	62,48	65,07	72,92	86,15	93,74	112,90	130,84	146,21	158,82	179,58
1000	63,81	66,98	75,55	88,43	97,85	117,82	136,31	150,94	166,08	188,30
1050	65,03	69,08	77,74	91,01	101,79	122,76	142,42	157,36	173,45	196,07
1100	66,24	71,12	80,57	93,12	105,80	128,13	147,99	163,79	180,72	204,48
1150	68,22	73,26	86,56	95,31	109,91	133,06	151,88	170,03	187,89	212,90
1200	69,84	75,17	85,76	98,53	113,94	138,22	157,36	176,46	195,14	218,89
1250	71,73	77,12	88,36	101,71	118,53	143,45	163,00	182,82	202,52	226,83
1300	73,62	79,20	90,15	104,89	122,99	148,67	168,53	189,19	209,78	235,05
1350	75,51	81,17	92,39	108,08	127,74	152,74	174,18	195,55	215,17	243,29
1400	77,41	83,12	94,42	111,26	132,44	157,22	179,71	201,91	221,57	251,50
1450	79,30	85,07	96,42	114,45	137,24	162,38	185,35	208,28	228,83	259,74
1500	81,19	87,16	98,42	117,62	141,92	167,53	190,89	213,09	236,01	267,95

Širina / Width (mm)

CENOVNIK ZA REŠETKE  
OBOJENE RAL BOJOM  
PLASTIFICIRANE

PRICE LIST FOR GRILLES  
PAINTED IN RAL COLOUR  
ELECTROSTATICALLY

#### NAPOMENA:

\* U slučaju kada imamo rešetku npr. 200x800 uzimamo cenu za rešetku 800x200.

\* Za neke specijalne RAL boje postoji dodatak u ceni. Pozovite nas za detaljnije informacije.

\* Postoji mogućnost skrivene ugradnje zavrtanjima koji bi se zavili kroz vrat rešetke (strana P2, crtež 2).

#### NOTES:

\* In the case where we have a grille i.e. 200x800 we can use the price of 800x200.

\* For some special RAL colours there is extra charge. Call us for more information.

\* Secret fixing is possible with screws in the neck of the grille (page P2, drawing 2).

# PROTIVKIŠNE REŠETKE WEATHER GRILLES



## BN-D-E-FA

- Zidna protivkišna rešetka/revizioni otvor za ubacivanje ili izvlačenje vazduha sa žičanom mrežom i regulatorom protoka sa suprotnosmernim lamelama i filterom
- Wall mount weather grille equipped with wire mesh. For intake or exhaust air from/to exterior. Accesible, with air filter and oposed blade damper for regulation of air flow.

### DIMENZIJE OTVORA / HOLE DIMENSION Visina / Height (mm)

CENOVNIK ZA REŠETKE OD  
ELOKSIRANOG ALUMINIJUMA  
U PRIRODNOJ BOJI

PRICELIST FOR GRILLES MADE  
OF ANODIZED ALUMINIUM  
IN NATURAL COLOUR

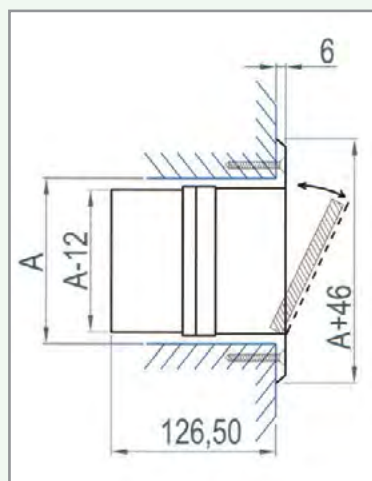

	100	125	150	200	250	300	350	400	450	500
200	37,67	37,67	37,67	37,67						
250	37,67	37,67	37,67	40,62	44,95					
300	37,67	38,60	41,01	44,65	50,43	57,14				
350	39,45	41,98	44,19	49,51	55,87	62,13	67,62			
400	42,43	44,97	47,86	54,28	59,60	68,75	76,45	85,01		
450	45,62	48,15	52,21	59,23	63,91	75,55	84,96	94,91	106,64	
500	48,61	52,03	56,40	63,13	69,87	81,98	94,43	102,95	113,56	121,94
550	51,87	56,07	60,65	66,99	75,41	88,76	102,89	111,39	122,07	133,29
600	55,43	60,13	65,12	71,92	80,43	95,32	109,73	120,15	130,57	145,46
650	57,73	62,51	67,98	75,70	84,62	100,76	114,21	127,07	138,90	155,47
700	60,04	65,03	69,74	79,49	88,70	104,56	120,39	134,00	147,12	165,47
750	62,99	67,48	72,24	84,03	94,73	109,50	128,71	143,36	157,42	177,23
800	64,94	69,70	75,55	89,00	100,09	117,26	141,19	152,93	162,00	184,12
850	67,28	71,70	78,71	93,24	104,37	123,83	146,68	161,59	174,19	196,27
900	69,62	73,67	81,74	97,49	108,56	130,40	152,06	170,25	184,44	208,40
950	72,10	76,73	85,61	102,56	114,34	137,11	159,53	178,68	194,65	221,82
1000	73,92	79,78	89,35	106,61	120,00	143,80	166,89	185,32	204,78	235,23
1050	76,00	82,77	94,23	110,33	125,07	149,58	174,43	193,29	214,50	240,27
1100	77,63	85,21	98,37	113,71	129,57	155,97	181,45	200,59	221,80	249,15
1150	80,46	88,33	104,89	116,31	135,20	161,27	186,07	208,54	231,00	260,72
1200	82,51	91,08	104,94	121,25	140,33	169,60	193,44	216,66	241,20	269,02
1250	85,23	94,28	109,21	125,49	146,66	176,64	201,76	226,01	251,67	280,39
1300	87,94	97,63	112,68	129,73	152,87	183,69	209,98	235,35	262,04	292,04
1350	90,66	100,84	116,60	133,98	159,20	189,58	218,31	244,69	270,53	303,70
1400	93,38	104,04	120,30	138,22	165,42	195,89	226,53	254,04	280,03	315,35
1450	96,09	107,25	123,98	142,46	171,75	202,87	234,85	263,38	290,39	327,01
1500	98,81	110,59	127,65	146,71	177,97	209,85	243,08	271,17	300,66	338,66

Širina / Width (mm)

### Visina / Height (mm)

	100	125	150	200	250	300	350	400	450	500
200	43,42	43,42	43,42	43,42						
250	43,42	43,42	43,42	46,36	50,70					
300	43,42	44,35	46,76	50,40	56,17	62,89				
350	45,20	47,73	49,94	55,26	61,62	67,88	73,37			
400	48,18	50,72	53,61	60,03	65,35	74,50	82,20	90,76		
450	51,37	53,90	57,96	64,99	69,66	81,30	90,71	100,66	112,39	
500	54,36	57,78	62,15	68,88	75,62	87,73	100,18	108,70	119,31	127,69
550	57,62	61,82	66,40	72,74	81,17	94,51	108,64	117,14	127,82	139,04
600	61,18	65,88	70,88	77,68	86,18	101,07	115,49	125,89	136,32	151,27
650	63,49	68,25	73,73	81,45	90,37	106,51	119,96	132,82	144,65	161,66
700	65,78	70,78	75,49	85,24	94,45	110,31	126,14	139,75	152,95	172,04
750	68,74	73,22	77,99	89,78	100,48	115,26	134,46	149,11	163,58	184,16
800	70,69	75,46	81,31	94,75	105,83	123,01	146,95	158,91	168,15	191,43
850	73,03	77,45	84,46	98,99	110,11	129,59	152,43	167,85	180,81	203,95
900	75,37	79,42	87,49	103,24	114,31	136,16	157,98	176,79	191,54	216,47
950	77,85	82,48	91,36	108,31	120,09	142,85	165,69	185,51	202,08	230,28
1000	79,67	85,53	95,09	112,36	125,75	149,55	173,28	192,42	212,53	244,10
1050	81,76	88,52	99,97	116,08	130,81	155,34	181,09	200,68	222,59	249,47
1100	83,39	90,96	104,11	119,46	135,32	161,98	188,36	208,26	230,20	258,73
1150	86,21	94,08	110,64	122,06	140,95	167,49	193,22	216,49	239,72	270,67
1200	88,26	96,83	110,69	126,99	146,07	176,05	200,83	224,89	250,23	279,35
1250	90,98	100,03	114,96	131,23	152,40	183,32	209,40	234,51	261,04	291,10
1300	93,69	103,37	118,43	135,48	158,62	190,61	217,86	244,14	271,72	303,12
1350	96,41	106,59	122,34	139,73	165,13	196,73	226,44	253,76	280,53	315,15
1400	99,13	109,79	126,05	143,97	171,57	203,27	234,90	263,38	290,36	327,17
1450	101,84	113,00	129,73	148,22	178,12	210,48	243,47	273,01	301,04	339,21
1500	104,56	116,34	133,40	152,46	184,56	217,70	251,94	281,07	311,64	351,23

Širina / Width (mm)

CENOVNIK ZA REŠETKE  
OBOJENE RAL BOJOM  
PLASTIFICIRANE

PRICE LIST FOR GRILLES  
PAINTED IN RAL COLOUR  
ELECTROSTATICALLY

#### NAPOMENA:

- \* U slučaju kada imamo rešetku npr. 200x800 uzimamo cenu za rešetku 800x200.
- \* Za neke specijalne RAL boje postoji dodatak u ceni. Pozovite nas za detaljnije informacije.
- \* Postoji mogućnost skrivene ugradnje zavrtanjima koji bi se zavili kroz vrat rešetke (strana P2, crtež 2).

#### NOTES:

- \* In the case where we have a grille i.e. 200x800 we can use the price of 800x200.
- \* For some special RAL colours there is extra charge. Call us for more information.
- \* Secret fixing is possible with screws in the neck of the grille (page P2, drawing 2).





### BN-IN

- ◆ Zidna protivkišna rešetka za ubacivanje ili izvlačenje vazduha od nerđajućeg čelika (304) sa žičanom mrežom. Najveća dimenzija 900x900mm.
- ◆ Wall mount weather grille made of inox (304) and equipped with wire mesh. For intake or exhaust air from/to exterior. Maximum dimension 900X900mm.

### DIMENZIJE OTVORA / HOLE DIMENSION

Visina / Height (mm)

	100	125	150	200	250	300	350	400	450	500
200	80,65	80,65	80,65	84,88						
250	80,65	80,65	80,65	87,79	94,92					
300	80,65	82,38	84,10	90,70	97,95	104,44				
350	82,62	85,08	87,55	93,61	100,98	107,60	113,33			
400	84,59	87,79	91,00	96,52	104,00	110,74	116,69	129,36		
450	86,56	90,50	94,45	99,85	107,02	113,90	120,05	132,26	138,85	
500	88,52	93,20	97,90	103,18	110,05	117,05	123,41	135,15	141,91	147,91
550	92,04	96,69	101,34	106,51	113,08	120,20	126,77	138,04	144,96	151,22
600	95,57	100,17	104,79	109,85	116,10	123,35	130,13	140,93	148,01	154,52
650	99,09	103,66	108,24	113,18	119,12	126,51	133,49	143,83	151,07	157,83
700	102,62	107,15	111,69	116,51	122,15	129,66	136,85	146,72	154,11	161,14
750	106,15	110,64	115,14	119,84	125,18	132,81	140,21	149,62	157,17	164,45
800	109,67	114,12	118,59	123,18	128,20	135,96	143,57	152,51	160,22	167,76
850	113,20	117,61	122,04	126,51	131,22	139,11	146,93	155,41	163,27	171,06
900	116,72	121,10	125,48	129,86	134,23	142,26	150,28	158,31	166,34	174,36

Širina / Width (mm)

